



BEASTX

MICROBEAST **PLUS**

6-AXIS MEMS SENSOR SYSTEM FOR RC-MODELS

Version 5.2

QUICKSTART GUIDE



STUDIOX.BEASTX.COM



BEASTX.COM



WIKI.BEASTX.COM

CE FC



SAFETY NOTES

- Radio controlled (R/C) helicopters are no toys! The rotor blades rotate at high speed and pose potential risk. They may cause severe injury due to improper usage. It is necessary to observe common safety rules for R/C models and the local law. You can gather information from your local R/C model club or from your national modelers association.
- Pay attention to your own safety and the safety of other people and property in your vicinity when using our product. Always fly in areas away from other people. Never use R/C models in close proximity to housing areas or crowds of people. R/C models may malfunction or crash due to several reasons like piloting mistakes or radio interference, and cause severe accidents. Pilots are fully responsible for their actions, and for damage or injuries caused by the usage of their models.
- Please read the following instructions thoroughly before the first use of your MICROBEAST PLUS and setup the system carefully according to this manual. Allow sufficient time for the setup procedure and check each step carefully. Watch for a mechanically clean and proper build of your helicopter. A wrong system setup can lead to a serious accident and damage to the model.
- Radio controlled (R/C) models consist of several electrical components. It is therefore necessary to protect the model from moisture and other foreign substances. If the model is exposed to moisture this may lead to a malfunction which may cause damage to the model or a crash. Never fly in the rain or extremely high humidity.
- When operating the helicopter with a MICROBEAST PLUS ensure there is a sufficiently large and stable receiver power supply. Because of the direct coupling of the rotor blades to the servos, without the use of a flybar mixer, the servos are exposed to increased actuating forces. In addition, because of the intermediary electronic gyro system, the servos are driven more often than with traditional use. These factors can make the power consumption increase a lot compared to a flybar helicopter. When the supply voltage falls below 3.5 volts for a short amount of time, the system will power off and reboot. In this case a crash of the helicopter is unavoidable.
- Do not expose the MICROBEAST PLUS system to extreme variations in temperature. Before powering up the system, wait some time so that the electronics can acclimatize and any accumulated condensation is able to evaporate.
- The sensors of MICROBEAST PLUS consist of highly sensitive electromechanical components. These can be damaged due to moisture or mechanical or electrical impact. Do not continue using this product, if it has been exposed to such influences, e.g. due to a crash of the model or due to overvoltage caused by a defective receiver power supply. Otherwise a failure may happen any time.
- When operating electric helicopters make sure that the electric motor cannot start inadvertently during the setup procedure. Particularly pay attention if using a single-line receiver and if the ESC is connected directly to the MICROBEAST PLUS. We recommend disconnecting the electric motor from the ESC during the setup procedure. Prior the first usage please slide the motor/pinion away from the main gear, then check that the motor does not start inadvertently when the receiver is switched on.

- When operating the RPM Governor feature of MICROBEAST PLUS it is essential to ensure that the motor cannot start by accident when making adjustment or performing preparations to start the engine. Carefully read this manual and make sure you fully understand how the RPM Governor feature is operated before making any adjustments. Also make sure the motor does not start when the radio link is interrupted or when you switch on the transmitter initially. With electric driven models do not dock the motor to the main gear unless all necessary adjustment procedures have been finished. Always maintain sufficient safety distance to the motor and other rapidly rotating components of the helicopter.
- MICROBEAST PLUS with AttitudeControl can be used as a flying aid for beginners by limiting the reaction of the helicopter to stick inputs and by stabilizing the helicopter with a electronic control loop. However, this does not provide that the helicopter can always be flown safely! By incorrect control inputs the helicopter still may crash or be placed in a position in which the pilot becomes disoriented even when using AttitudeControl. In addition, the helicopter can drift due to external influences and it is not guaranteed that the artificial horizon of the device can stabilize the helicopter at any time and recover from any orientation. Influences such as temperature fluctuations or vibrations may cause incorrect results and distort the position calculation of the system in consequence. There is no guarantee that the system will always work correctly. Only the pilot is responsible for the control of the helicopter and thus also for the use of the system. Note that the system for technical reasons will not hold the helicopter absolutely to the point. The unstable tendency of a helicopter will cause the model to fly in a certain direction even when using AttitudeControl. External influences such as wind can further strengthen this effect. In addition measurement inaccuracies of the sensors can distort the position determination slightly. You must always be able to turn off the system immediately and be able to take over full control of the helicopter.
- We suggest you to seek the support of an experienced helicopter pilot before you undertake the first flight of your model. Additionally, flight training with a R/C simulator can help make flying easier and more enjoyable. Ask your local dealer if you need technical support or if you observe problems during the usage of our system.
- AttitudeControl can help to facilitate flying of model helicopters by briefly passing over control to the system if the pilot becomes disoriented. By using the built-in artificial horizon the helicopter can be brought to a nearly horizontal position so that the pilot gains time to reorient. Thus, there can be no assurance that the model is saved from a crash in general. Depending on the current attitude and the speed of the model and depending on how fast the AttitudeControl is activated, the model may crash before or while the system tries to recover. In addition, the helicopter can drift due to external influences and it is not guaranteed that the artificial horizon of the device can stabilize the helicopter at any time and recover from any orientation. Influences such as temperature fluctuations or vibrations may cause incorrect results and distort the position calculation of the system in consequence. Strictly observe the general safety rules for dealing with RC models and do not totally rely on the system. The pilot is responsible for the control of the helicopter and thus also for the use of the system. You must always be able to turn off the system immediately and be able to take over full control of the helicopter.



MICROBEAST PLUS

6-AXIS MEMS SENSOR SYSTEM FOR RC-MODELS

Dear customer,
thank you for purchasing our product.

MICROBEAST PLUS is a high-end gyro system for RC helicopters that has been developed in Germany using latest technology and setting high standards. It can be used with many different types of helicopters like 3D aerobatic helis, F3C competition helicopters as well as scale helicopters with 2 or more rotorblades. The system comes with BASIC flybarless stabilization functionality and can be upgraded by paid update to the PROEDITION. This enables additional features like „AttitudeControl“ for recue bailout or constant leveling and a feature called „Bank Switching“ that allows to switch between parameter presets in flight to serve different flight conditions or flying styles.

To setup MICROBEAST PLUS there is no need for any additional devices. All you need is your radio system and your helicopter. Thanks to the well proven „EasySetup“ concept you can do all the necessary adjustment directly at the device and you're ready for take off within a few minutes.

This Quickstart Guide is a clearly arranged guide that will lead you step-by-step through the basic flight setup. Please follow this guide carefully and make sure to read the attached safety notes. For a detailed instruction manual and further details, tips, tricks and notes about the product please visit

WIKI.BEASTX.COM

Designed for **STUDIOX**

If you like to get more insight into the system and like to have a more visualized type of setup you can use the StudioX App for PC/mac or StudioXm for your smartphone/tablet in combination with the USB2SYS interface (PC/mac) or BLE2SYS interface (smartphone/tablet) (optional available). These apps are the source to get even more out of your device like saving/restoring parameters, firmware updates, loading preset heli configurations and making advanced adjustment to fully customize your MICROBEAST PLUS to your needs.

StudioX can be downloaded from:

STUDIOX.BEASTX.COM

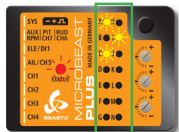

This guide is intended to be used with MICROBEAST PLUS firmware version 5.2.x only! After power up when the Status-LED lights red, for a few seconds in the left row menu LEDs **A** and **B** indicate major version „5“. The yellow LED next to **1** stands for „2“.

1. HARDWARE INSTALLATION

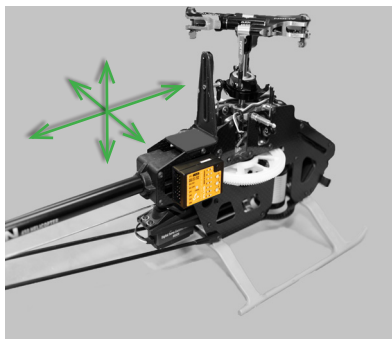
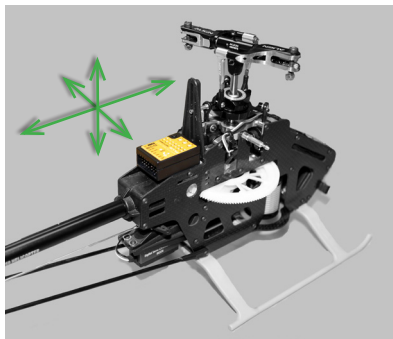

You can position MICROBEAST PLUS flat or upright on the helicopter. The large socket must point to the front or to the rear of the helicopter. The small white socket must be aligned with the longitudinal axis.

The sensor axis (housing edges of the device) must be aligned exactly parallel to all three rotation axis of the helicopter. However, it is allowed to position the device offset from the rotation axis.

In summary there are 8 mounting orientations possible:

1. flat, sticker on top, socket pointing to front
2. upright, button up, socket pointing to front
3. flat, sticker showing to ground, socket pointing to front
4. upright, button down, socket pointing to front
5. flat, sticker on top, socket pointing to rear
6. upright, button up, socket pointing to rear
7. flat, sticker showing to ground, socket pointing to rear
8. upright, button down, socket pointing to rear



1.



2.



3.



4.



5.



6.



7.



8.

Flight direction

Use one of the supplied 3M gyro pads to stick the device to your helicopter. The device housing must not directly touch the chassis of the helicopter. When connecting and laying out the servo and receiver wiring later onwards, please make sure the wires do not pass tension to the MICROBEAST PLUS. It is not recommended to bundle or tie down the leads close to the MICROBEAST PLUS device!

2. CONNECTING THE RECEIVER

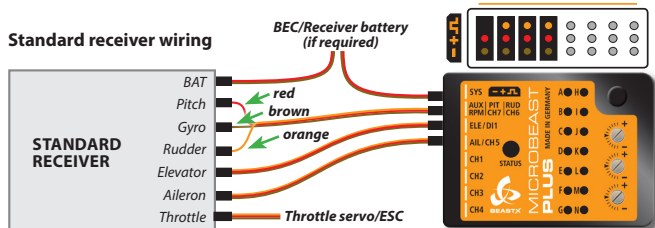

The illustration is only an example. The function assignment of your transmitter determines which channel on the receiver controls which function!

The assignment of functions to the radio channels is mentioned in the manual of your radio system. Also you can find out the function assignment by checking your transmitter's servo monitor. The connectors of MICROBEAST PLUS are assigned to the functions as follows:

AIL|CH5 = Aileron, ELE|D11 = Elevator, RUD (orange wire) = Rudder, PIT (red wire) = Thrust, Aux (brown wire) = Gyro gain

The wires for aileron and elevator additionally transfer the power between MICROBEAST PLUS and receiver.

Single-Line receivers

Using a **Single-Line receiver** all channels/functions are transferred by one single connection wire. This allows to use even more than 5 channels, i. e. for controlling the headspeed Governor, AttitudeControl function and additional output channels. Always make sure the power supply is stable and dimensioned sufficiently for the intended application. If possible always connect the power source directly to MICROBEAST PLUS (not at port [AUX|PIT|RUD]) in order to minimize contact resistance. Additional supply cables can be plugged into free receiver ports. Especially when using standard size servos it is recommended to use more than one power supply cable in parallel to preserve a stable voltage and to reduce power loss due to connection resistance.

Wiring scheme for Single-Line receivers with following transmission protocols:

- JR® XBus (Mode B), Multiplex® SRXL (V1+V2)
- Jeti® UDI, Jeti® EXBUS
- Graupner/SJ® HOTT SUND
- Spektrum® SRXL
- Futaba® SBUS
- ALIGN/FlySky iBUS
- PPM serial signal (SPPM)

Remote satellite: DSM2/DSMX, ALIGN iBUS, JR RJ-01 DMSS

Using a remote satellite is only intended for 450 size helis or smaller!

For larger helis please use a full-size Single-Line receiver for your radio brand (i.e. SRXL).

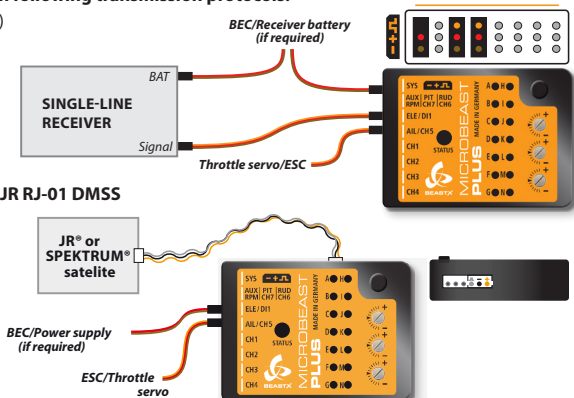

To initiate bind procedure for a Spektrum® DSM2/DSMX remote satellite, connect the Spektrum® bind plug to [SYS] port. When using a **DSM2** remote satellite, **push and hold the button**. Turn on power while still holding the button down. The LED on the satellite will flash together with Menu LED **(N)** on MICROBEAST PLUS. When binding a **DSMX** remote satellite **do not touch the button**, only power on the device. The LED on the satellite will flash together with Menu LED **(I)**. Initiate the bind procedure on the transmitter. Power off and remove the bind plug when finished successfully.

To bind other receivers refer to the manual of receiver or radio system. There is no action required with MICROBEAST PLUS.

Spektrum® SRXL2 receivers

Spektrum® receivers with SRXL2 output must be connected at the side of MICROBEAST PLUS. Having a receiver with standard type servo connector, the optional available adapter BXA76403 is required in order to connect the SRXL2 port with MICROBEAST PLUS.

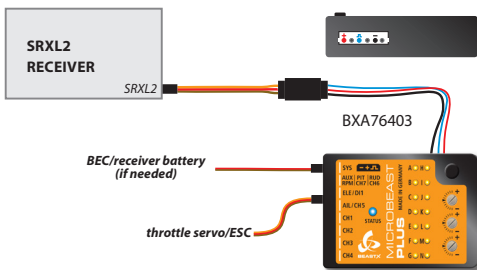

A Spektrum® SRXL2 satellite receiver with 4-wire signal line can be connected directly to the side of MICROBEAST PLUS.

ATTENTION: The polarity of the cable must be swapped on the input side of MICROBEAST PLUS! On MICROBEAST PLUS the outmost pin is +3.3V, the pin next to it is minus.

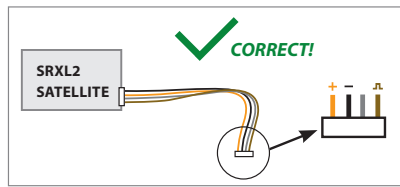
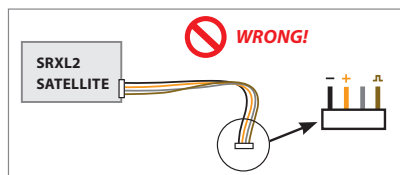
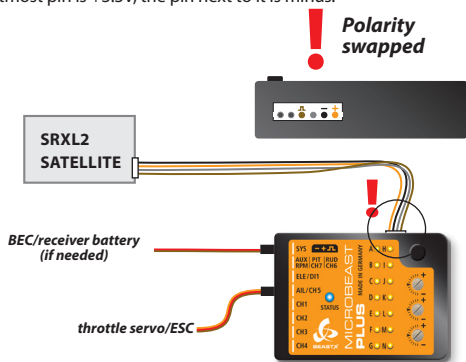

3. PREPARING YOUR TRANSMITTER

Create a new helicopter model memory in your transmitter that supplies different flight modes for controlling throttle, pitch and the tail gyro gain in different flight situations.

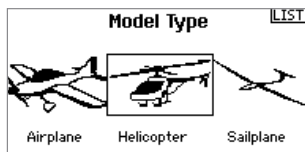
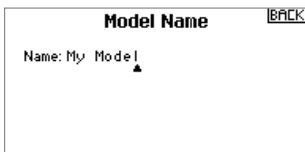
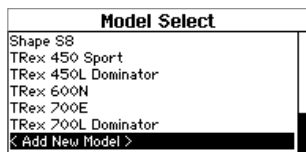

You mustn't use any mixing functions on the output channels! Especially it is not allowed to use mixing functions for the swashplate servos. Deactivate all output channels that are not used. In the basic configuration we only need pitch, aileron, elevator, rudder, throttle and one channel to adjust the tail gyro gain.

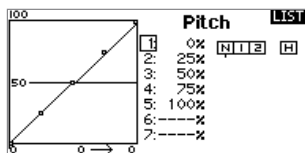
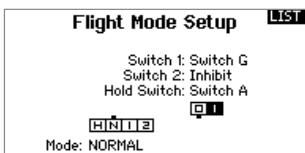
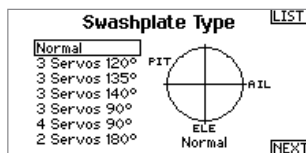

Each control function must exactly control one output channel. Initially the servo throws must be set to 100% and all trims and sub trims must be zero. For the basic setup do not change the pitch curves yet. The throttle curves and throttle servo settings can be adjusted as necessary for this model in case you do not intend to use the internal Headspeed Governor function of MICROBEAST PLUS.

Only the pitch channel must be controlled when moving the thrust stick. The same applies to aileron, elevator and rudder.

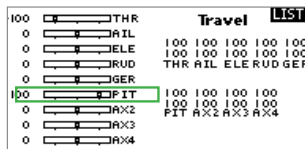
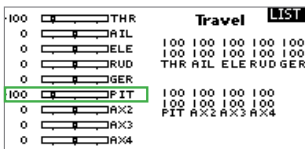

⚠ For safety reason, remove the motor from the main gear when performing the basic setup on electric driven models! Additionally deactivate the throttle by using the „Throttle Hold“ switch, so the motor won't start to turn by accident when moving the thrust stick.

When flying a **nitro or gasser heli** remove the servo horn from the throttle servo before first power up. This prevents jamming the servo due to wrong servo setup!

4. RECEIVER SETUP

To enter RECEIVER MENU MICROBEAST PLUS must be switched off completely. Push and hold the button before and while powering on. The menu LEDs will start to cycle from **A** to **N**. Now you can release the button.

Make sure your transmitter is on and sending signals to the receiver. At menu point **A** you can start automatic receiver type detection by briefly pressing the button once. The color of the Status LED indicates which type is currently scanned for. When the receiver has been detected the menu will skip to point **B**; when there was some error the Status LED will flash in red color and the menu stays at **A**. In this case please make sure you've connected the receiver correctly and try again!

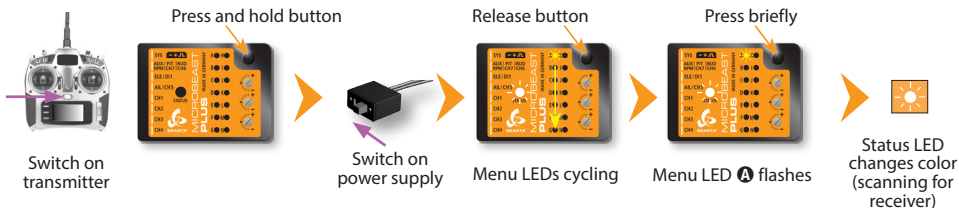

Single-Line receiver (Status LED purple or blue at menu point **A**)

When at menu point **B** press and hold the button for 2 seconds to load the default function assignment that has been preset for the detected radio system. Alternatively you may program a different function assignment manually, in case the default assignment does not match to your transmitter's function layout. How this works in detail you can read from the detailed instruction manual which you can get at wiki.beastx.com.

Preset function assignment for the different single-line receiver protocols (indicated by Status LED color at **A** and **B**):

Spektrum® DSM2/DSMX/SRXL2, JR® RJ-01 DMSS or ALIGN® iBus remote satellite

THR	AIL	ELE	RUD	GER	PIT	AX2	AX3
Throttle [CH5]	Aileron	Elevator	Rudder	Gyro gain	Pitch	Aux [CH6]	Governor*

PPM serial signal (SPPM)

1	2	3	4	5	6	7	8
Pitch	Aileron	Elevator	Rudder	Aux [CH6]	Throttle [CH5]	Gyro gain	Governor*

Futaba® SBus/SBus2 or BEASTX FASST compatible receiver

1	2	3	4	5	6	7	8
Aileron	Elevator	Throttle [CH5]	Rudder	Gyro gain	Pitch	Aux [CH6]	Governor*

Multiplex® SRXL (V1/V2), JR® XBUS Mode B, JETI® UDI

1	2	3	4	5	6	7	8
Aileron	Elevator	Rudder	Pitch	Throttle [CH5]	Gyro gain	Aux [CH6]	Governor*

Graupner® SUMD

1	2	3	4	5	6	7	8
Pitch	Aileron	Elevator	Rudder	Aux [CH6]	Throttle [CH5]	Gyro gain	Governor*

Spektrum® SRXL

THR	AIL	ELE	RUD	GER	PIT	AX2	AX3
Throttle [CH5]	Aileron	Elevator	Rudder	Gyro gain	Pitch	Aux [CH6]	Governor*

Jeti® EXBUS

1	2	3	4	5	6	7	8
Throttle [CH5]	Aileron	Elevator	Pitch	Rudder	Gyro gain	Aux [CH6]	Governor*

* Governor channel is used to set headspeed for governor function with nitro or gas driven helicopters

Press and hold button
for 2 seconds



Menu LED **B** flashes
Status LED is **solid blue**

Release button



Menu LED **N** flashes
Status LED flashes **red/blue**



Make sure throttle is
in motor stop/failsafe
position

Press briefly



⚠ WARNING: At menu point 1 the throttle output CH5 is active, when using a electric helicopter the motor may start to run! Move the throttle to the desired failsafe position which is needed in case the receiver connection is interrupted oder gets disconnected. When a valid throttle position is detected, the Status LED flashes **blue**.

When pushing the button after setting throttle failsafe position all the receiver settings will be stored. Then all menu LEDs will flash repeatedly and the system will reboot after 3 seconds.

Receiver with „Standard“ 5-wire layout (Status LED off at menu point 1)

Here the function assignment is simply determined by the order of physical connection of the wires to the receiver outputs. Assignment by software is not provided and will not appear when choosing this type of receiver. When a „Standard“ receiver (Status LED **blue** at menu point 1) was detected the receiver setup is finished and the system will reboot immediately. Menu point **B** will not appear!

5. BASIC HELI SETUP (SETUP MENU)

After power up or finishing RECEIVER MENU adjustment wait until the system has initialized

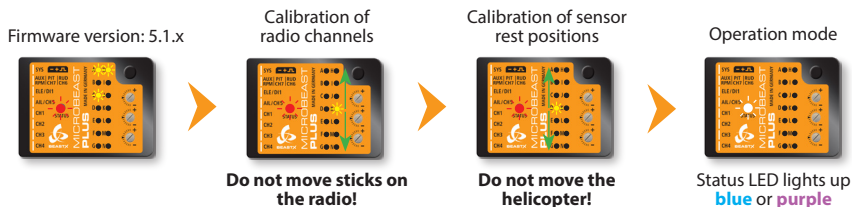

Then enter SETUP MENU for making the basic adjustments

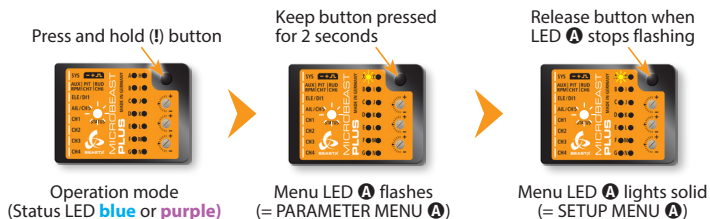

Setup menu point (A) - Device orientation (Menu LED (A) solid lit up)

Check the selected device orientation and change it if necessary by (repeatedly) moving the rudder stick into one direction until the Status LED color corresponds to the real device orientation. Then briefly push the button to save the setting and to proceed to the next menu point.

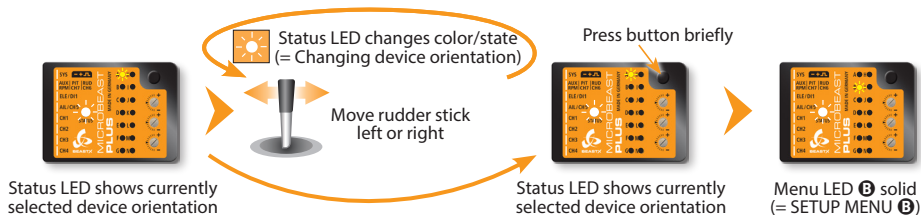

Large socket points to **nose of the heli**



Status LED **off***



Status LED **flashing purple**



Status LED **purple**



Status LED **flashing red**



Status LED **red**



Status LED **flashing blue**



Status LED **blue**



Status LED flashing **red/blue**

Large socket points to **tail of the heli**

Setup menu points **B**, **C** and **D**

Adjust swashplate update rate (**B**), rudder servo pulse width (**C**) and rudder update rate (**D**) again by moving the rudder stick to one or another direction until the Status LED lights in the correct color necessary for the servos used in your helicopter. Briefly pressing the button will ~~store the selected option~~ and skip to the next menu point.

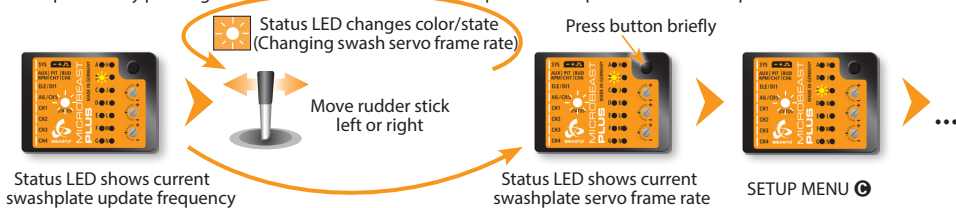

Status LED	purple	flashing red	red	flashing blue	blue
B Swashplate update rate	50 Hz*	65 Hz	120 Hz	120 Hz	200 Hz
C Rudder servo pulse width	760 μ s	-	960 μ s	-	1520 μ s*
D Rudder update rate	50 Hz*	120 Hz	270 Hz	333 Hz	(560 Hz)

⚠️ If you don't know the which update rate is best for your servos, never use more than 50Hz.

The higher the update rate the better it is for the flight performance of MICROBEAST PLUS. But you must check the servo specifications before increasing the update rate. Otherwise the servos may get damaged! For a list with parameter examples for most common servo types see WIKI.BEASTX.COM.

For the rudder servo always use 1520 μ s servo pulse width, except you're using a very special type of servo with reduced pulse width (only these servo can be used with an increased update rate of 560 Hz!). Check the servo data sheet!

Setup menu point ③ - Rudder servo limit

Plug the rudder servo connector into [CH4] output of MICROBEAST PLUS. Put the servo arm on the servo so that it forms roughly an angle of 90 degrees with the rudder linkage rod and adjust the length of the linkage rod as described in the helicopter manual.

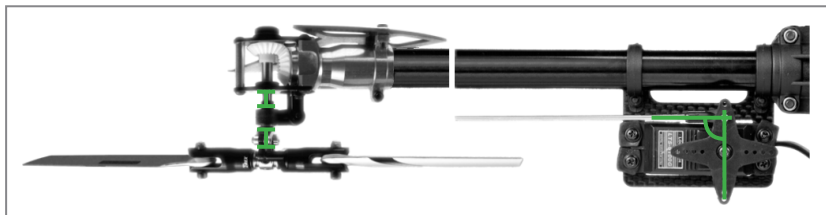

Push and hold the rudder stick into one direction to move the rudder servo and release the stick when the servo reaches the maximum or minimum allowed servo throw. Using the rudder stick you can reposition the servo at any time to adjust the exact servo limit. If you do not touch the rudder stick for several seconds the current servo position will be saved as maximum or minimum (the Status LED will flash and then light up solid in **blue** or **red** color). Then move the servo to the opposite direction, adjust as described above and wait until also this position gets stored (now Status LED becomes **purple**).



Menu LED ③ solid
Status LED off



Use rudder stick to move the servo to the maximum allowed deflection

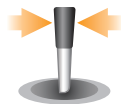

Release rudder stick



Status LED
blue or **red**



Use rudder stick to move the servo to the minimum allowed deflection

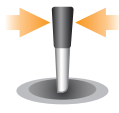

Release rudder stick

Press button briefly



Status LED
purple



Menu LED ③ solid
(= SETUP MENU ③)

Setup menu point ② - Rudder direction

1. Move the rudder stick and check the rudder direction on the helicopter



Correct



Tail rotor pushes tail left, so heli turns to right.

Wrong



Tail rotor pushes tail right, so heli turns to left.

If the stick is moving the servo into the wrong direction use **the servo reverse function of your transmitter** and reverse the rudder channel to change stick control direction.

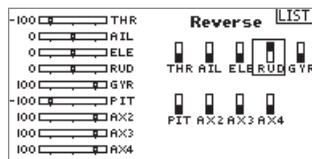

2. Now set the rudder direction of the MICROBEAST PLUS gyro

When you move the rudder stick to the **right**, the Status LED must light up or flash in **blue** color. When you move the rudder stick to the **left**, the Status LED must light up or flash in **red** color. When the display is inverted (red = right and blue = left) reverse the display (internal control direction) by tapping the aileron(!) stick once.



Rudder stick to the right

Correct



Status LED **blue**



Tap aileron stick to swap colors

Wrong



Status LED **red**

Always set servo direction in the transmitter first, then check the display on the MICROBEAST PLUS or in the software and change the internal control direction if it does not match the real direction. **Do not change the internal direction in order to change the servo direction! This is only used for telling the gyro in which direction it must move the servo.** Be very conscientious when doing this setup step, as wrong gyro direction will cause loss of control during takeoff and you probably crash the helicopter!

3. **Optional:** When you move the rudder stick to full deflection, the Status LED should light solid, not just flash. If this is not the case, increase the servo throw/endpoint of the rudder channel in the transmitter just as far so that the Status LED changes from flashing to solid when the rudder stick reaches the end position. Note: Do not increase the endpoint too much in the transmitter. We need an exact match of full stick position and stick end position, the Status LED should just change from flashing to solid when reaching the end position.

Setup menu point ③ - Swashplate mixing type



Status LED shows currently selected mixing type

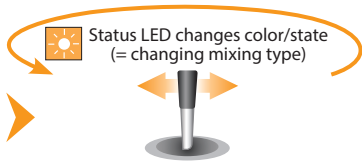

Move rudder stick left or right



Status LED shows currently selected mixing type

Status LED	purple	flashing red	red	flashing blue	blue
③ Swashplate mixing type	mechanical	90°	120°	140°	135°/140° (1:1)

For **ALIGN® T-Rex helicopters** you can keep the default setting of 120 degrees electronic swash mixing (Status LED **solid red**).

⚠ Never use any swashplate mixing in your transmitter even when electronic mixing is required!

Deactivate the swashplate mixing in your transmitter or set it to mechanical mixing (which is often called "normal", "H1" or "1" servo" mixing), so that each stick function only moves one receiver output channel. The swashplate mixing is all done by MICROBEAST PLUS!

In the following connect the servos to the outputs marked with **CH1 to CH3 (CH7)** as shown below. With electronic swashplate mixing the two aileron servos have to be connected to CH2 (=left) and CH3 (=right). With a mechanical mixed head (H1) the aileron servo connects to CH2 and collective pitch servo to CH3. Plug the the elevator servo into CH1 port. When using a scale helicopter with 90 degrees eCCPM you can connect a second elevator servo to CH7 output on the MICROBEAST PLUS. Note that CH7 only is a signal output, so you must power the servo from elsewhere, i.e. by getting power from the SYS-port or CH5 using a Y-adaptor (for + and - only!).

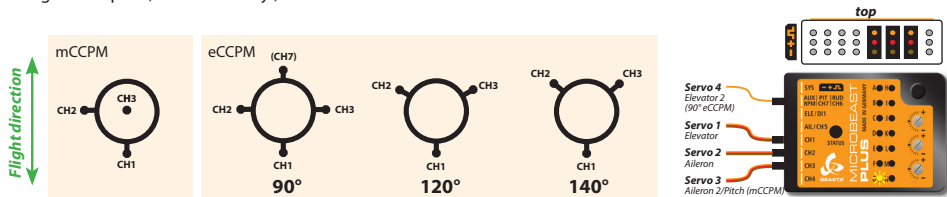

When you route the wire leads in your model make sure that there is no tension passed to the MICROBEAST PLUS. Make sure that MICROBEAST PLUS is able to move freely, so no vibrations get passed onto the unit by the wire leads. Do not use any shrink tubing or fabric hose to bundle or encase the wiring in close proximity to the point at which the cables are plugged into the MICROBEAST PLUS. This makes the cables stiff and inflexible and can cause vibrations being transmitted to MICROBEAST PLUS.

Setup menu point ④ - Swashplate servo directions

Move the thrust stick and check whether all servos push the swashplate up and down simultaneously. If this is not the case by tapping the rudder stick you can select one servo after another. Every color of the Status-LED is corresponding to a specific servo channel that is indicating its selection by a short up and down move. Then tap the aileron stick once to switch the servo direction of the selected servo. You can switch back and forth between the servos as often as you need.

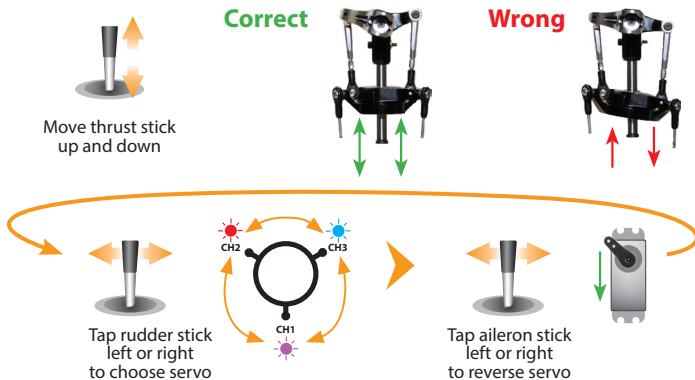

After adjusting servo directions, finally make sure that the pitch direction is correct! You can either do this by setting the servo directions correctly right from the beginning or by changing the direction of the pitch control channel in the transmitter.

Please note: It's not possible to reverse the servos with the servo reverse function of your transmitter! The transmitter only controls the functions of MICROBEAST PLUS, not the servos! Reversing a channel in the transmitter will reverse the control function in total, not the direction of a single servo (except when using mCCPM swashplate mixing).

Setup menu point ① - Swashplate control directions

1. Move the stick(s) for aileron and elevator on the radio and check whether the swashplate is moved in the correct directions on the helicopter. The swashplate must follow the stick movement; pushing elevator forward will tilt the swashplate forwards, adding aileron to the right will move the swash to the right and so on. **If the stick is moving the swashplate into the wrong direction use the reverse function of your transmitter** and reverse the aileron and/or elevator channel to set stick control direction correctly.

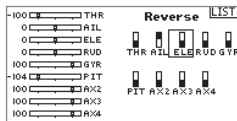
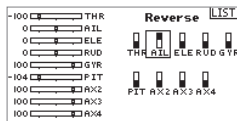

2. Now when the swashplate moves correctly, set the internal control direction of the MICROBEAST PLUS gyro. Pushing elevator forward and steering aileron to the right, the Status LED must light in **blue** color. If it doesn't, tap the rudder stick until this is the case.

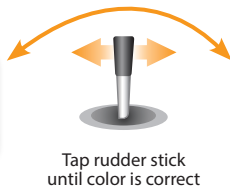

There are four possible options, only one is correct! Always set control directions in the transmitter first, then check the display on the MICROBEAST PLUS or in the software and change the internal control direction, if it does not match the real direction. **Be very careful here as this teaches the control directions to the system.** When the directions are not set correctly, the system will move the helicopter into wrong direction which will result in a crash!

Setup menu point ① - Swashplate servo trim

At SETUP MENU point J we trim the servo center positions, so that each servo horn forms an exact 90 degrees angle with the adjustment linkage. This is necessary as you will not be able to attach the servo horns in exact center position to the servo. After all servos have been trimmed do not proceed to the next menu point, yet. With active trimming, adjust the linkage rods according to your helicopter's manual.

Initially when the trimming is 0 on all servos the Status LED will be off. Attach the servo horns in center position as good as possible. By tapping the rudder stick you can select one servo after another. Every color of the Status-LED is corresponding to a specific servo channel that is indicating its selection by a short up and down move. Use the aileron stick to change the servo trimming/adjust the center position of the selected servo. You can switch back and forth between the servos as often as you need.

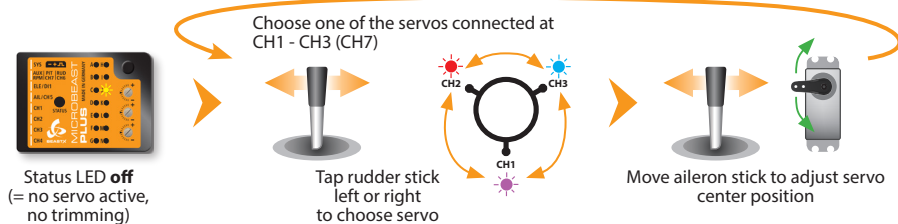

When you've perfectly adjusted the servos now adjust the linkage rods going from servos to the swashplate and from the swashplate to the blade grips. The swashplate must be leveled and centered on the main shaft and the blade grips should be set to 0° of pitch.

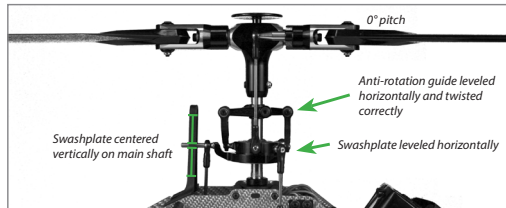

If necessary adjust the swashplate anti-rotation guide so that the swashplate phasing is not shifted (only applies to 2-blade rotorheads).

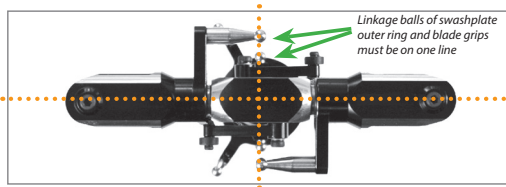

Hint: To reset the servo trims push and hold the button for at least 10 seconds.

Optional: Push and hold the button for 2 seconds, then release. This will switch into the washplate trim mode.

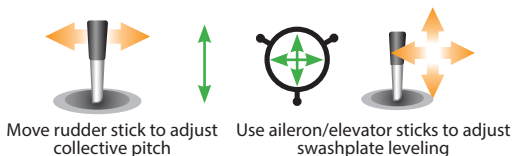

Setup menu point **K** - Swashplate servo throw

At SETUP MENU point K we adjust the internal servo throw so that MICROBEAST PLUS has a reference on how far it must move the servos when controlling the helicopter. To set the throw you have to align one rotorblade on the longitudinal axis (in parallel to the tail boom) and measure the cyclic pitch with a digital pitch gauge on this rotorblade.

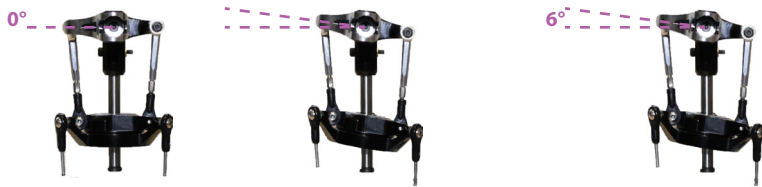

Menu LED **K** solid
Status LED off



Tap rudder stick to switch to measure position

Use aileron stick to adjust blade pitch to exact **exact +6 or -6 degrees**

Status LED **should** be solid **blue** (see instruction manual for further details on the LED colors)

Setup menu point **L** - Collective pitch

1. Set internal control direction

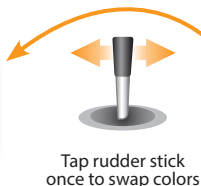

2. The Status LED must light solid **blue**, not just flash. If this is not the case, **increase the servo throw/endpoint of the pitch channel in the transmitter just as far so that the Status LED changes from flashing to solid when the thrust stick reaches the end position**. But do not increase the endpoint too much in the radio! Use an exact match of full stick position and stick end position, the Status LED should just change from flashing to solid when reaching the end position.

3. Now use aileron stick to adjust maximum **positive collective pitch** (i. e. $+12^\circ$)

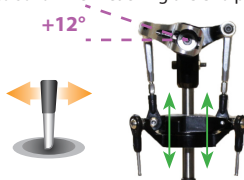

4. Finally move thrust stick to full negative position and repeat steps 2. and 3. for the **negative pitch**. Here Status LED is **red**.

Do not change control direction (with rudder stick) anymore!

	THR	AIL	EL	RUD	GYR	PIT	RC2	RC3	RC4
100	100	100	100	100	100	100	100	100	100
0	100	100	100	100	100	100	100	100	100
0	100	100	100	100	100	100	100	100	100
0	100	100	100	100	100	100	100	100	100
104	100	100	100	100	100	100	100	100	100
0	100	100	100	100	100	100	100	100	100
0	100	100	100	100	100	100	100	100	100
0	100	100	100	100	100	100	100	100	100
0	100	100	100	100	100	100	100	100	100

Travel LIST
THR AIL EL RUD GYR
PIT RC2 RC3 RC4

Setup menu point **M** - Swashplate servo limit

You can remove the pitch gauge now! Simultaneously move the sticks for thrust, aileron and elevator to the maximum deflection and check if the servos, swashplate or linkages get jammed in a certain position. By pushing and holding the rudder stick left or right you can increase or decrease the limit for the servos! Adjust the limit so that the servos just don't get jammed in any possible stick position but don't limit the servos more than necessary.

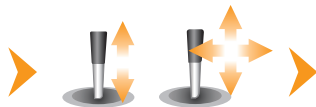

Setup menu point **M** - Internal Headspeed Governor

This menu point is only accessible if you're **not using a Standard type receiver!** Otherwise pressing the button at menu point **M** will exit the menu and lead back to operation mode.

Enable the Headspeed Governor function by choosing the type of drive system of your helicopter. If you're using the governor function of the ESC or an external governor or if you want to fly without headspeed governing at all, choose „Governor off“.

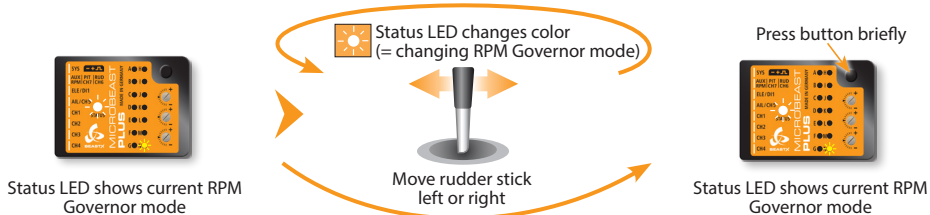

Status LED	off	red	blue
M Internal Governor	Governor off*	electric heli	nitro/gas heli

When you're using the Headspeed Governor of MICROBEAST PLUS now connect the RPM sensor (i. e. magnetical, optical or brushless phase sensor) or the wire for RPM signal of your ESC to the white sensorport on the long side. For this you may need the optional available BXA76401 adapter.

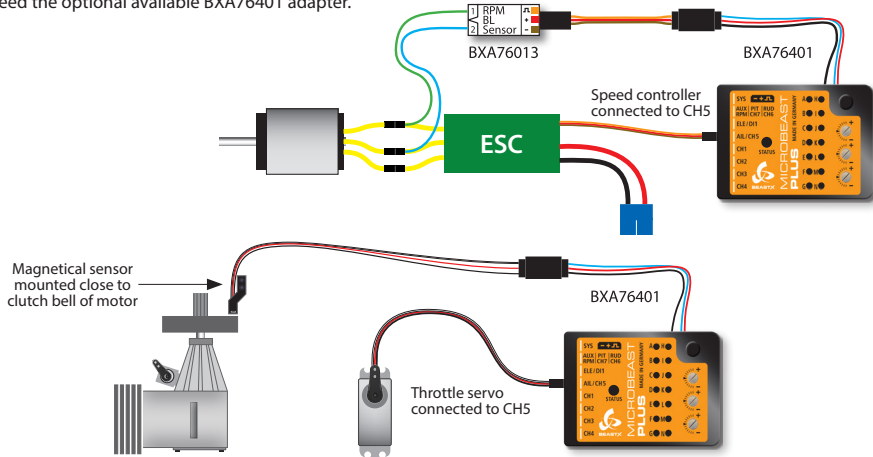

6. GOVERNOR SETUP MENU

Governor menu point A - Test mode (Menu LED A flashing slowly)

If the Governor was activated at SETUP MENU point N (set to „electric“ or „nitro/gas heli“) you will access the Governor menu immediately afterwards. At point A we check if the speed sensor is functioning properly and if the sensor wire is connected correctly.

**Electric heli with
brushless phase sensor**



Nitro/Gas heli

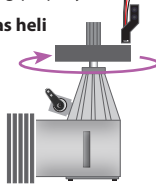

Menü LED A flashes
Status LED off

Rotate the motor by hand.
The Status LED must light red

Turn clutch bell by hand

Status LED solid blue
when magnet triggers sensor

When using a helicopter with combustion engine adjust the throttle servo positions in the transmitter (servo throw and servo center) and setup the throttle on the heli (throttle linkage rod length and servo arm position), if necessary. Attach the servo horn at thrust mid stick position. The throttle linkage must form a right angle with the servo horn. Adjust the length of the linkage according to the instructions of the helicopter, so that it also is positioned perpendicular to the linkage lever at the carburetor. The carburetor must be opened halfway (note the markings on the carburetor!). Then adjust the servo throw so the carburetor can be fully opened and fully closed without jamming the throttle servo.

Thrust in mid
stick position



Servo arm and throttle
lever in parallel and
perpendicular to linkage rod

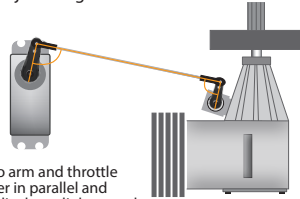

Governor menu point B - Motor off/Idle position

Using an electric heli move the throttle to the position at which the motor is just before to start running, i.e. by adding throttle until the motor starts to turn and then reducing the throttle a little. With a nitro/gas heli move the throttle to a stable idle position.

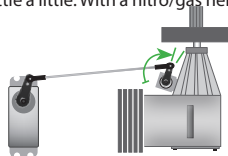
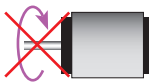

Menü LED B flashes
Status LED off

Move throttle to position at which the motor is just before to
start running (electric heli) or idle position (nitro/gas heli)

Press button briefly

Status LED blue
when throttle
position registered

Governor menu point **Ⓞ** - Full throttle position

Move throttle to maximum position. **Note:** In electric governor mode the throttle input will not be passed to CH5 output to prevent from motor damage by running the motor without load! Thus, you have to check before that the full throttle position runs the motor at maximum speed in reality, i.e. by correctly programming your throttle end points in the transmitter or ESC.



Menu LED **Ⓞ** flashes
Status LED **off**



MAX RPM

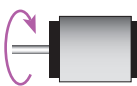

Move throttle to maximum position

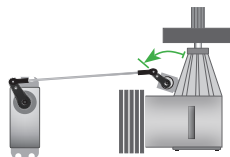

Press button briefly



Status LED **blue**
when throttle
position registered

Governor menu point **Ⓧ** - Transmitter setup

Here we can set the desired rotor headspeed and throttle curves. The Status LED can be used to verify the transmitter setup. Governor off = **off**, Autorotation = **purple**, Gov active = **red** or **blue** (at max. RPM).

When using an **electric heli** the throttle is completely independent from the thrust stick. The throttle curves are set to horizontal lines which stand for a certain headspeed and governor operation mode. Using the flight mode switch you can switch between the different curves/rpm presets in the transmitter.

Motor off

- Throttle 0% over the entire range

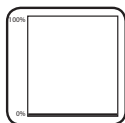

Status LED **off**

Idle up

- Throttle set between 15% and 100% equals headspeed of 800 - 5000rpm
- +5% = +247rpm

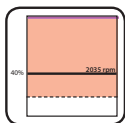

Status LED **red**
or **blue**

Autorotation

- Throttle greater 0% and smaller 15%
- Motor off
- When switching back to idle up motor will restart quickly

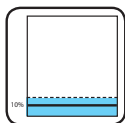

Status LED **purple**

The Governor for **nitro/gas models** can be operated in two different ways: One possibility is to operate the governor using the **throttle channel similar to the electric mode**. Only difference here is that the the range below 50% throttle is used to manually control the throttle servo, i. e. for starting the motor. The range above 50% activates the governor and presets a specific rotor headspeed just like in electric mode.

Manual control

- Range between 0% und 50% directly controls the throttle servo from idle to fully opened position

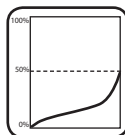

Status LED **off**

Idle up

- Throttle set between 50% and 100% equals headspeed of 500 - 3000rpm
- +5% = +250rpm

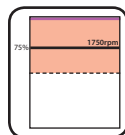

Status LED **red**
or **blue**

Autorotation

- Throttle in idle position
- When switching back to idle up (>50%) motor will restart quickly
- Switching back to manual control (<40%) will disable governor

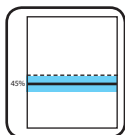

Status LED **purple**

The second option to control the Governor for **nitro/gas helicopters** is to use a **separate switch channel**. Here the throttle curves/throttle channel is used for manual throttle servo control only. The Governor is activated and the headspeed is set by using the additional channel. When the throttle channel is above 25% and a headspeed is set, the Governor will activate and control the headspeed. Moving the throttle channel below 25% will switch to Autorotation mode.

Manual control

- Throttle curve controls servo
- Governor off
- Governor channel below 5% (-90)

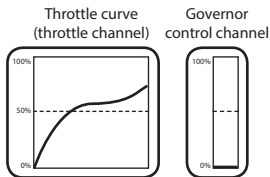

Idle up

- Governor channel set between 5% and 100% (or -90 and +100 on some transmitters) equals headspeed of 500 - 3000rpm
- +5% (or 10 clicks) = +131rpm
- throttle channel must stay above 25%

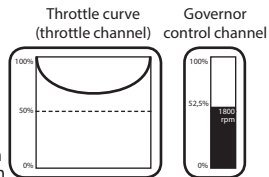

Which nitro governor mode you're using depends on whether you've assigned a switch channel to control the governor at the RECEIVER MENU function assignment or not. You can find out which mode you're using by watching the Status LED display here while moving the throttle!

For proper governing the headspeed should not be set higher than 80% of the maximum possible headspeed of the helicopter. When using the nitro governor, make sure that slow rampup speed and fast rampup speed are not set too high in PARAMETER MENU. Otherwise the throttle may be opened too quick and may lock in at full throttle position.

Governor menu point **E** - Signal divider

Electric helicopter with brushless phase sensor or phase signal from ESC: signal divider = motor pole count : 2
 Nitro/Gas helicopter with magnetical or optical sensor: signal divider = number of triggers (i.e. magnets or optical markers)

Status LED	off	flashing purple	purple	flashing red	red	flashing blue	blue
E Signal divider	1	2	3	4*	5	6	7

Governor menu points **F** **G** **H** - Main gear ratio

When the helicopter has a single stage main gear: **Main gear ratio** = **Main gear tooth count** : **Motor pinion tooth count**
 Set the Status LED color/state at each of the menu points **F**, **G** and **H** so that the main gear ratio can be calculated as sum of the three menu points, i.e. 8.55:1 = **F** flashing purple + **G** flashing red + **H** red

Status LED	off	flashing purple	purple	flashing red	red	flashing blue	blue	red/blue
F	custom	8.00	9.00*	10.00	11.00	12.00	13.00	14.00
G		+0.00	+0.20	+0.40*	+0.60	+0.80		
H		+0.00	+0.05	+0.10*	+0.15			

7. FLYING AND OPTIMIZATION

The **tail gyro gain** is adjusted by one of the transmitter's auxiliary channels. The more servo throw this channel produces, the higher the tail gyro gain will be. The direction of servo throw determines whether the gyro works in Normal-Rate mode or in HeadingLock mode. The color of the Status-LED indicates the selected mode when MICROBEAST PLUS is operational. Purple means Normal-Rate and blue indicates HeadingLock mode. When changing the gain and after initialization sequence the amount of gain is displayed by one of the Menu LEDs for 4 seconds.

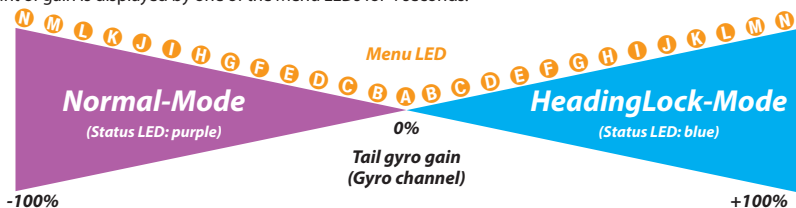

For the first flight we suggest to use HeadingLock mode (Status LED **blue**) and start with medium gain (not higher than LED **Ⓞ**). In case the tail of the helicopter starts to oscillate with high frequency in flight, immediately reduce the gain! If on the other hand the rudder control feels imprecise and the gyro doesn't hold position very well, increase the gain. Most radio systems provide an automatic switching for the tail gyro gain depending on flight modes. In the flight mode with the lowest rotor headspeed you can use the most gain. Reduce the gain the higher the headspeed is. **Before the first flight make sure the tail gain is set correctly and is also set when switching flight modes.** Use the LED display to see how the gyro is setup and do not rely upon the values of your transmitter as signs and percentages may vary depending on radio brand and radio type!

Before the first take off make a stick direction check and check if swash and tail gyro are correcting to the right direction when you tilt, roll or yaw the helicopter by hand. Just before lift-off make sure that the washplate is horizontal and that the tail pitch slider is close to center position. Avoid excessive steering during lift-off otherwise the helicopter may tip over! The best way is to give a fair and direct collective pitch input to lift the helicopter quickly up into the air.

Adjusting the **three dials** on top of MICROBEAST PLUS you can optimize the control loop and customize it to your helicopter. For the first flight all three dials should be centered. If necessary only adjust one dial at a time and only in little steps. Turning a dial clockwise will increase the effect, turning it counter-clockwise will decrease the effect of the parameter.



1 - Cyclic gain

The higher the gain the harder the helicopter will stop after cyclic moves and the more stable and precise the helicopter will fly. If the gain is too high the helicopter will tend to shake (especially on the elevator axis) as the system overcompensates. With low gain the helicopter does not stop precisely and overshoots after a cyclic movement. Additionally it is unstable and control feels sluggish. Due to their low mass small helicopters typically do not need as much gain as large helicopters.

2 - Cyclic feed forward

Feed forward connects the servo movements with your stick inputs, bypassing the control loop. This will give a more natural control feel and quicker reactions to stick inputs. But if the cyclic feed forward is too high, stick control will fight against the control loop. The heli will bounce back when stopping from a cyclic movement and it will react over sensitive and pitch up easily in fast forward flight.

3 - Tail gyro response

Increasing the tail gyro response will cause harder stopping and more aggressive response to rudder stick inputs. If response is set too high, the tail will bounce back when doing a hard stop (especially when turning against rotor torque). If the dynamic is set too low, the rudder control feels dull and stopping is very soft. Ideally the tail should stop perfectly to the point without making any flapping noises.

8. PARAMETER MENU

The PARAMETER MENU allows you to further customize the flight characteristics of the helicopter and the reaction of the system to control inputs. You can find a detailed description for each parameter in the MICROBEAST PLUS instruction manual.

Entering PARAMETER MENU

Press and hold button



Operation mode
(Status LED is
blue or purple)

Release button



Menu LED A flashing



Menu LED A flashing
(= PARAMETER MENU A)

Menu point A - Swashplate quick trim (Menu LED A flashing)

Move the stick(s) for aileron and elevator to trim the swashplate into the desired direction. With rudder you can trim the collective up/down. When using the tail gyro in Normal-Rate mode you can trim the rudder servo with the rudder stick. To delete all trimming push and hold the button for at least 10 seconds.

Menu points B to K

Color and state of the Status LED indicate which option is currently selected at each menu point. By pushing the rudder stick repeatedly you can cycle through the available options at each menu point and change the setting if necessary. Briefly pushing the button will skip to the next menu point. After the last menu point the system will exit PARAMETER MENU and change back to operation mode.

Status LED	off	purple	flashing red	red	flashing blue	blue
B Control style	custom	normal	sport*	pro	extreme	TX mode
C Speed flight stability	custom	very low	low	medium*	high	very high
D Rudder rate consistency	custom	very low	low	medium*	high	very high
E Stick deadzone	custom	very small	small*	medium	large	very large
F Torque precompensation	custom	off	low - nor.	high - nor.	low - inv.	high - inv.
G Cyclic response	custom	normal*	slightly increased	increased	aggressive	very aggressive
H Pitch boost	custom	off*	low	medium	high	very high
I Throttle response	soft	normal*	slightly increased	increased	aggressive	very aggressive
J Slow rampup speed	custom	50 rps	100 rps	200 rps*	300 rps	400 rps
K Fast rampup speed	custom	using slow rampup speed	300 rps	500 rps*	700 rps	900 rps

DECLARATION OF CONFORMITY

We

BEASTX GmbH
Karl-Ferdinand-Braun-Str. 33
50170 Kerpen
Germany

herewith declare that **MICROBEAST PLUS** / **MICROBEAST PLUS HD** meet all the essential requirements of the Directives 2004/108/EC und 2011/65/EU. For the evaluation of compliance with these Directives the following standards where applied:

EN 61000-6-1:2007
EN 61000-6-3:2007 + A1:2011 + AC:2012

The products carry the CE mark:



The products mentioned above are fully compliant with requirements stipulated by REACH (1907/2006/EC) and RoHS (2011/65/EC), where applicable. Furthermore, the articles and their packaging materials do not contain substances included on the current candidate list for authorization (SVHC list) according to Art. 33 and 59(1, 10) REACH in a concentration above 0.1 % weight by weight. The candidate list and its updates are closely monitored on a regular basis. In addition, our products do not contain any substances subject to authorization or restriction (REACH Annexes XIV and XVII).

Kerpen, 01.08.2014

place and date of issue

Markus Schaack, CEO

name and signature

LEGAL TERMS

All statements in this document have been checked for accuracy, integrity and actuality. However, potential mistakes cannot be excluded. We are not responsible for any damage which occurs as a result of these contents. Do not hesitate to send us any suggestions for improvement by e-mail to info@beastx.com.

This product contains chemicals known to the State of California to cause cancer, birth defects or other reproductive harm.

The actual contents of this publication are protected by copyright law. All rights reserved.

BEASTX, **MICROBEAST** and **SRXL** are registered trademarks.



SETUP MENU

(Menu LED solid)

		off	flashing purple	purple	flashing red	red	flashing blue	blue	flashing red/blue
A	Device orientation	R	horizontal pins to front	vertical pins to front	hor. inv. pins to front	vertical pins to back	vertical pins to back	hor. inv. pins to back	vert. inv. pins to back
B	Swashplate frequency	R	custom		50 Hz*	65 Hz	120 Hz	165 Hz	200 Hz
C	Rudder pulse width	R	custom		760 µs		960 µs		1520 µs*
D	Rudder frequency	R	custom		50 Hz*	165 Hz	270 Hz	333 Hz	(560 Hz)
E	Rudder limits	R	Use rudder to move servo to one endpoint and wait until LED flashes, then move to the other endpoint and wait.						
F	Rudder direction	A				left		right	
G	Swash mixing	R	custom		no mixing	90°(3/4 servos)	120°*	140°	135°/140°(1:1)
H	Servo directions	RA		Servo CH1		Servo CH2		Servo CH3	(Servo CH7)
I	Cyclic control directions	R				left/back		right/forward	
J	Servo trim / Swashplate trim	RA	no trim*		Servo CH1		Servo CH2		Servo CH3 (Servo CH7)
K	Cyclic throw (Set to 6 degrees!)	RA			not good		OK		perfect
L	Collective pitch	RA			check throw!	negative	check throw!	positive	
M	Servo limit	R				left/back		right/forward	
N	Headspeed Governor	R	Governor off*					nitro/gas heli	

GOVERNOR SETUP MENU

(Menu LED flashing slowly)

		off	flashing purple	purple	flashing red	red	flashing blue	blue	flashing red/blue
A	Test mode		nitro/gas heli: Status-LED blue when magnet passes sensor electric heli: Status-LED red when motor is running						
B	Motor off/idle position	T	nitro/gas heli: throttle servo to (increased) idle position electric heli: throttle in „motor off“ position, just before motor starts (▲ throttle unlocked!)						
C	Full throttle position	T	Set full throttle position (electric heli: motor speed does not change anymore - nitro/gas heli: servo at maximum)						
D	Transmitter setup		Governor off	Autorotation		Governor on		Governor on max. RPM	
E	Signal divider	R	1	2	3	4*	5	6	7
F		R	custom	8	9*	10	11	12	13
G	Main gear ratio (Sum of ② + ③ + ④ if not „custom“)		+0.00	+0.20	+0.40*	+0.60	+0.80		
H			+0.00	+0.05	+0.10*	+0.15			

Enter SETUP MENU by pressing button for at least 2 seconds in operation mode. Skip to next Menu Point by pressing button briefly, after last point menu will exit.

R Use rudder to adjust value/choose setting

A Use aileron to switch menu option

T Set throttle to desired position if you like to change the setting

* Default setting: hold button for 10 seconds at any Menu Point (except ④) to reset setup and parameter data. Holding button at ④ only the trims will be reset!



PARAMETER MENU

(Menu LED flashing quickly)

	off	purple	flashing red	red	flashing blue	blue
A Quick trim	Gyro in HL Mode: Trim aileron and elevator with stick, use rudder to trim collective. Gyro in Rate Mode: Rudder stick trims rudder. AttitudeControl active: Adjust roll and pitch angle of horizon with aileron and elevator stick. Any mode: Reset all servo trims by holding button for 10 seconds.					
B Control style	custom	normal	sport*	pro	extreme	TX mode
C Speed flight stability	custom	very low	low	medium*	high	very high
D Rudder rate consistency	custom	very low	low	medium*	high	very high
E Stick deadzone	custom	very small	small*	medium	large	very large
F Torque precompensation	custom	off*	low - inv.	high - inv.	low - nor.	high - nor.
G Cyclic response	custom	normal*	slightly increased	increased	aggressive	very aggressive
H Pitch boost	custom	off*	low	medium	high	very high
I Throttle response	soft	normal*	slightly increased	increased	aggressive	very aggressive
J Slow spool up rate	custom	50 rps	100 rps	200 rps*	300 rps	400 rps
K Quick change rate	custom	= slow spool up	300 rps	500 rps*	700 rps	900 rps
L AttitudeControl mode	disabled*	Angular mode	Bail out rescue	Bail out w. pitch	3D Mode	3D Mode w. pitch
M AttitudeControl pitch	> 0%	> 30%	> 50%	> 50%	> 70%	> 70%

Enter PARAMETER MENU by pressing button briefly in operation mode. Use rudder to adjust value/choose setting (except at **A**). Skip to next Menu Point by pressing button briefly, after last point menu will exit.

* Default setting - hold button for 10 seconds when in SETUP MENU (!) to reset everything to default (except receiver settings)

RECEIVER MENU

(Menu LED flashing)

	off	purple	red	blue
A Receiver type	Standard RX	Remote satellite	None	Serial signal on D11
B Pitch channel	Move the stick/channel on transmitter you want to assign. The Status-LED will flash in blue or purple color when channel was detected. When Status-LED flashes red, two or more channels have been moved! Menu points H , I and L can be skipped in case you don't want to use the specific function or if you want to use the nitro RPM Governor or AttitudeControl without separate switch channel. To load the default assignment common to your radio system keep the button pressed for 2 seconds and release. You will directly jump to menu point L . Move throttle to failsafe position (▲ throttle unlocked!) and push button to save and exit.			
C Aileron channel				
D Elevator channel				
E Rudder channel				
F Gyro channel				
G Throttle channel				
H Aux channel (CH6)				
I Governor channel				
J AttitudeControl channel				
N Throttle failsafe				

Enter RECEIVER MENU by pressing and holding button before (!) and while power up. Skip to next Menu Point by pressing button briefly (at Menu Point **A** short button press will initiate automatic receiver detection). When Standard RX is used menu will exit after detection!

Please note: AttitudeControl options are only accessible when PROEDITION firmware upgrade is installed.